

data sheet: H7G50

Kroepelin GmbH
Gartenstraße 50
D-36381 Schlüchtern

Tel.: 06661 86 0
Fax: 06661 86 39
Mail: sales@kroepelin.com
Web: www.kroepelin.com

Kroepelin
Längenmesstechnik

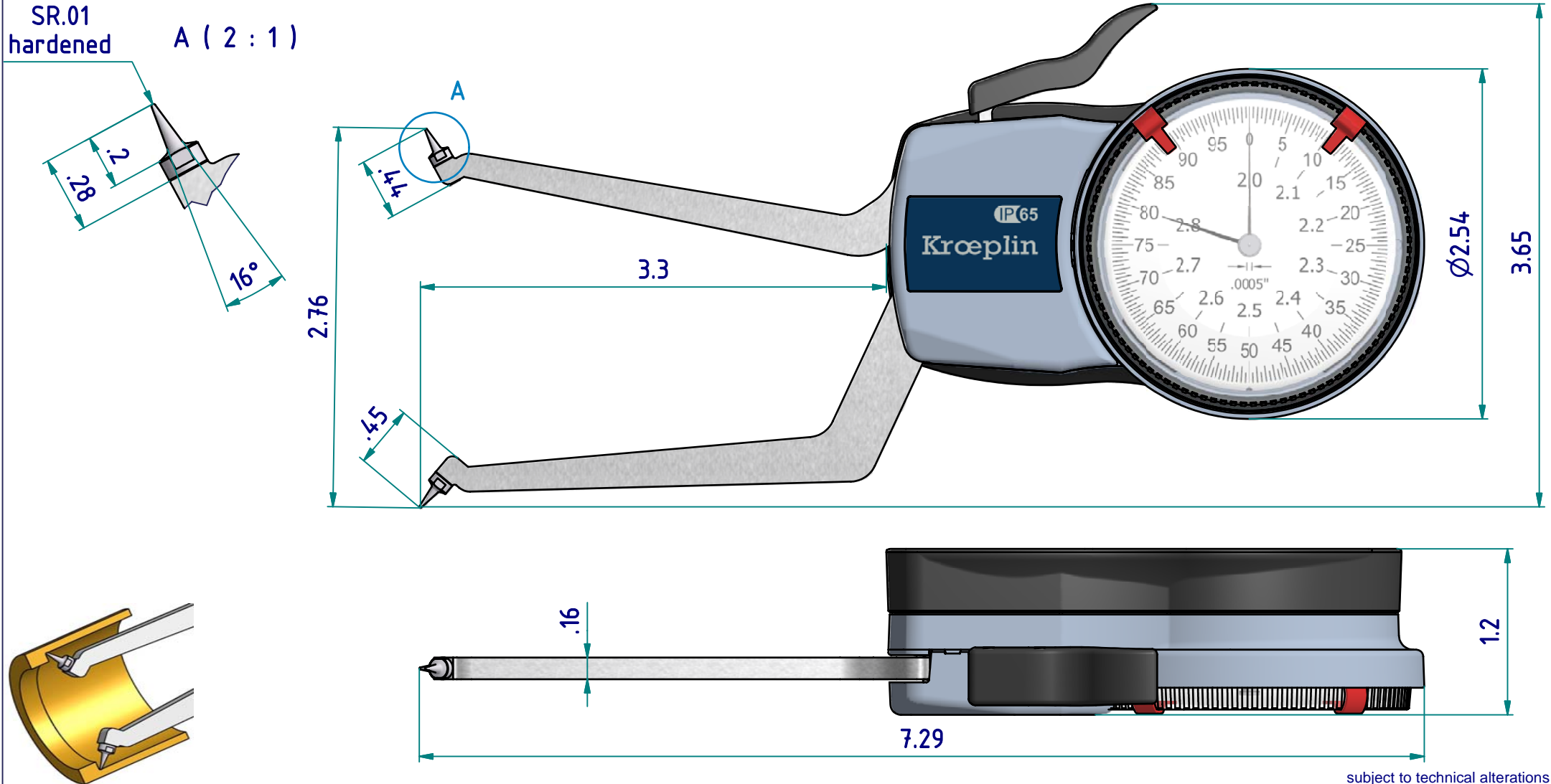

subject to technical alterations

type: H
range: 2.00 - 2.80 INCH
range of indication: 1.98 - 2.81 INCH
digital step: -
scale interval: .0005 INCH
measuring force: 1,1 - 1,6 N
weight: 195 g

acceptable deviations
VDI/VDE/DGQ 2618 Bl. 12.1/13.1)
max. permissible errors "G": .0015 INCH
repeatability "r": .0005 INCH
reference temperature: 20° C
operation temperature: 10° C - 30° C
storage temperature: -10° C - 50° C

scale: 1:1
drawing-nr.: DAB-H7G50_KR_I
date of issue: 12.01.09
name: T.Koenig
revision status:
revision date: